

STANDARD CASING OPTIONS

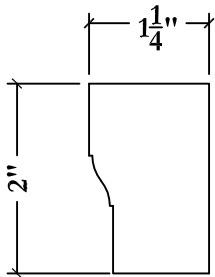

BRICKMOLD

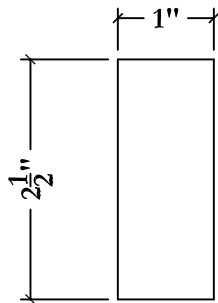

STANDARD FLAT CASING

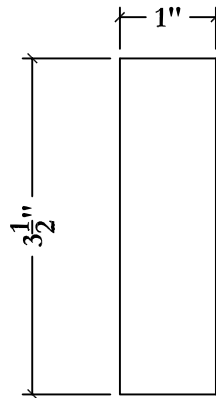

STANDARD FLAT CASING

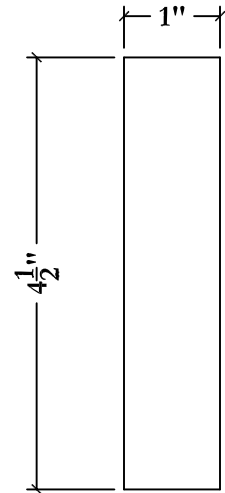

STANDARD FLAT CASING

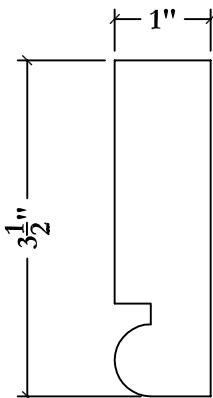

STANDARD W/BEAD DETAIL

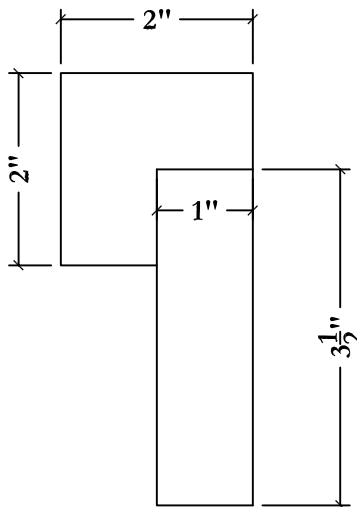

STANDARD FLAT CASING WITH BACKBAND

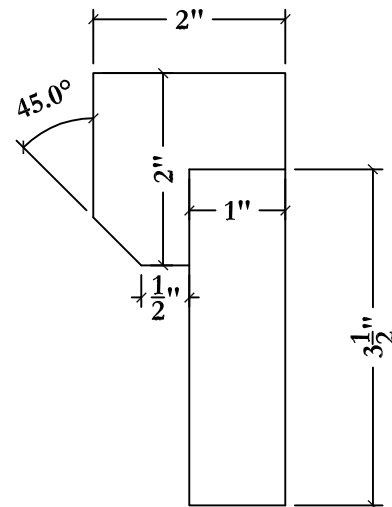

STANDARD FLAT CASING WITH CHAMFERED BACKBAND