

PROFILE 8.1

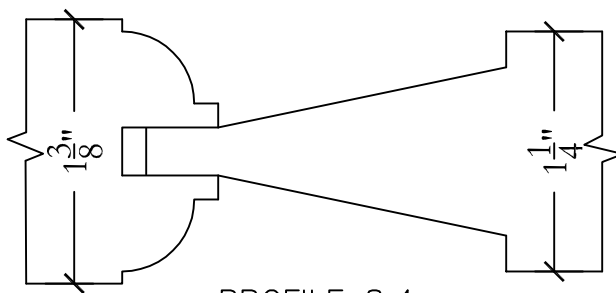

PROFILE 8.4

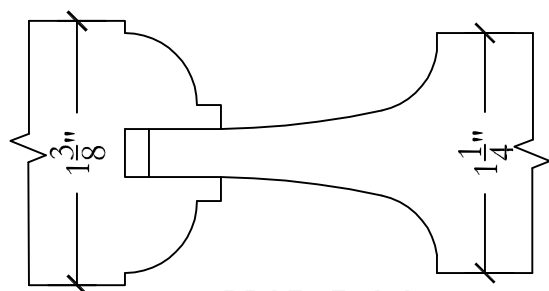

PROFILE 8.2

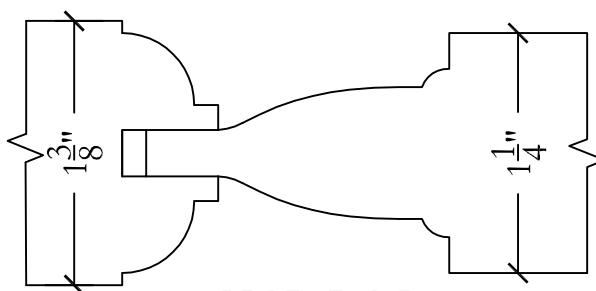

PROFILE 8.5

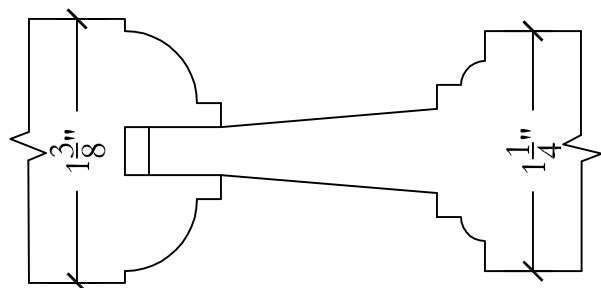

PROFILE 8.3

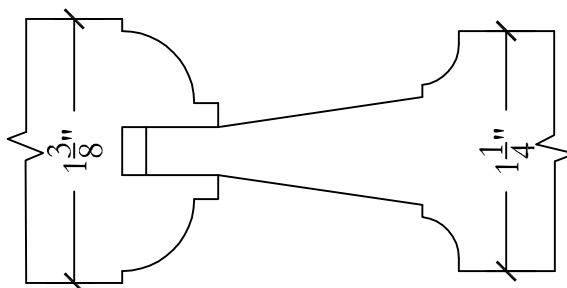

PROFILE 8.6

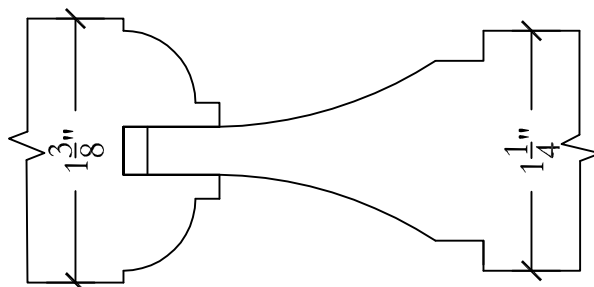

PROFILE 8.7

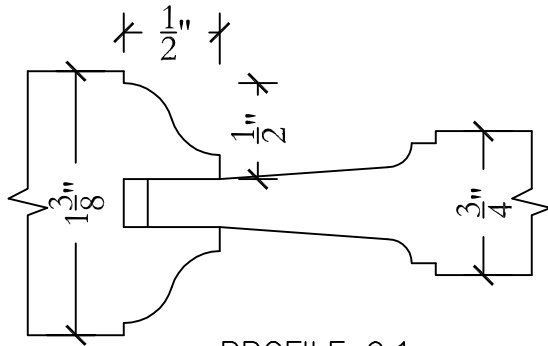

PROFILE 9.1

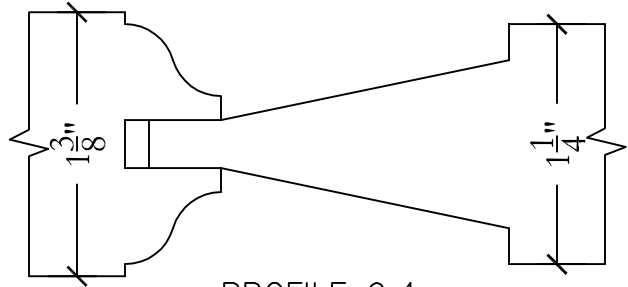

PROFILE 9.4

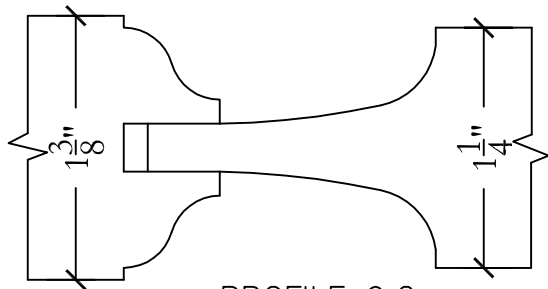

PROFILE 9.2

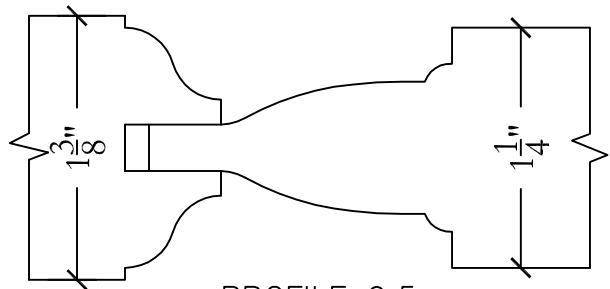

PROFILE 9.5

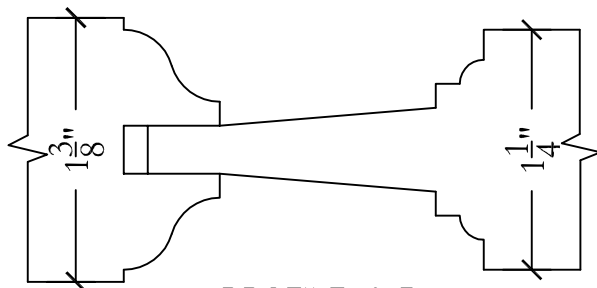

PROFILE 9.3

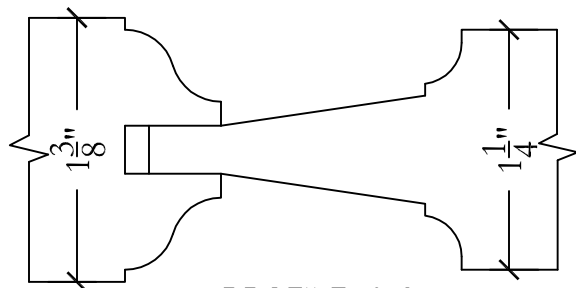

PROFILE 9.6

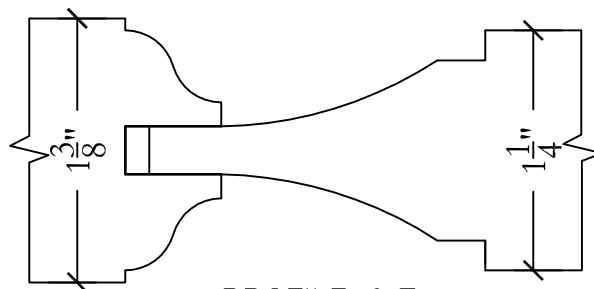

PROFILE 9.7

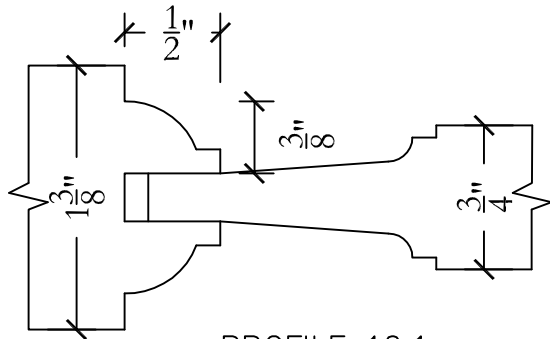

PROFILE 10.1

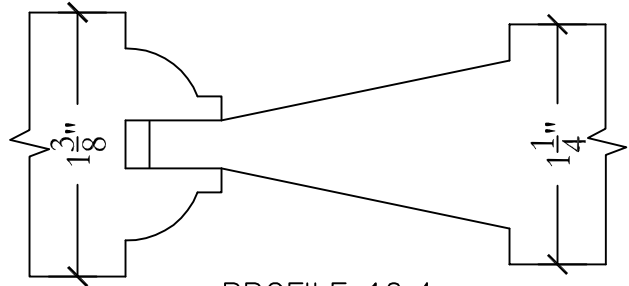

PROFILE 10.4

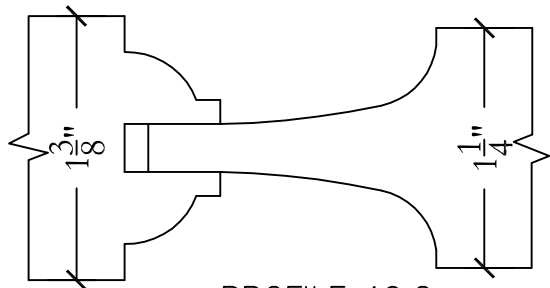

PROFILE 10.2

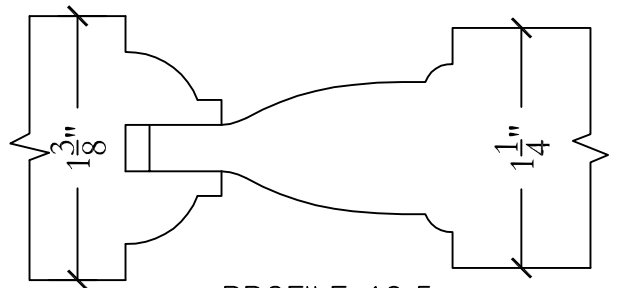

PROFILE 10.5

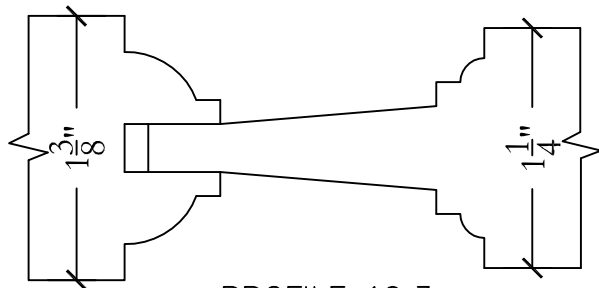

PROFILE 10.3

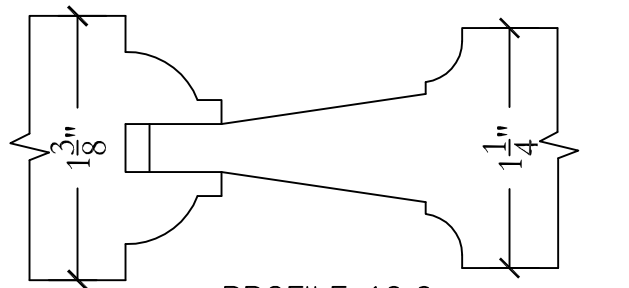

PROFILE 10.6

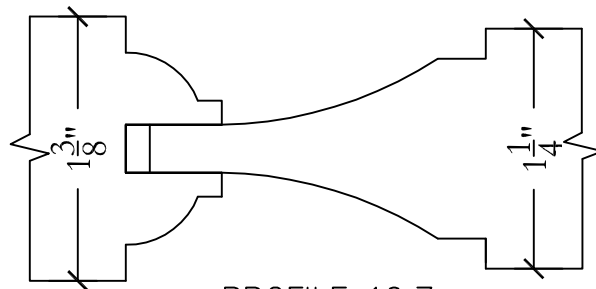

PROFILE 10.7

Typical mass produced profile

Cope: 1/2" x 1/2"  
(all dimensions on flat)

**Scale: Full**

p 800.570.8283 ~ www.upstatedoor.com ~ sales@upstatedoor.com

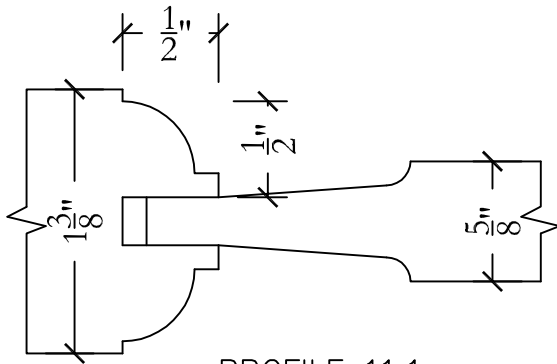

PROFILE 11.1

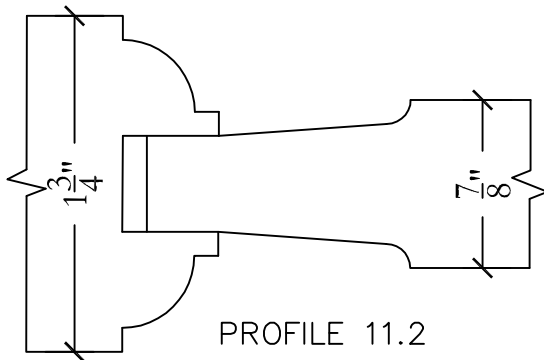

PROFILE 11.2