

Note: Panel thickness will increase with tongue thickness.

PR9

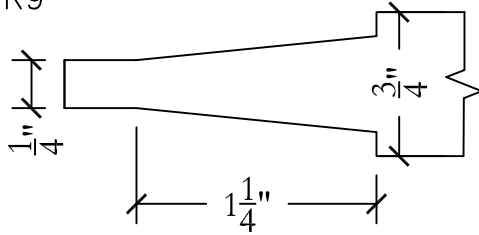

PR13

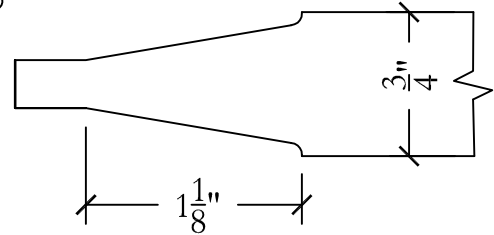

PR10

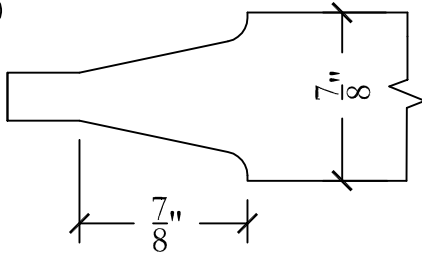

PR14

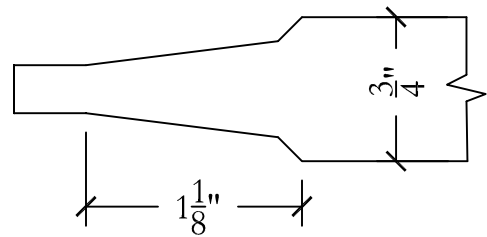

PR11

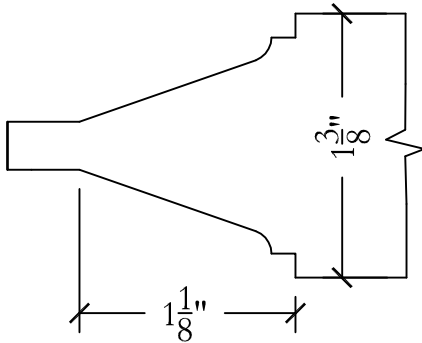

PR15

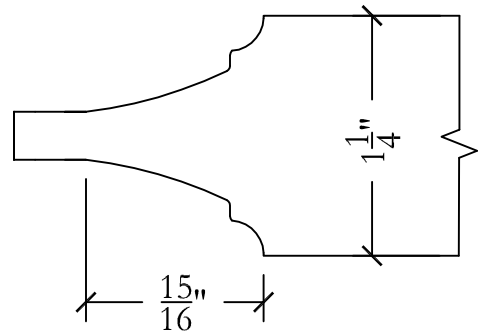

PR12

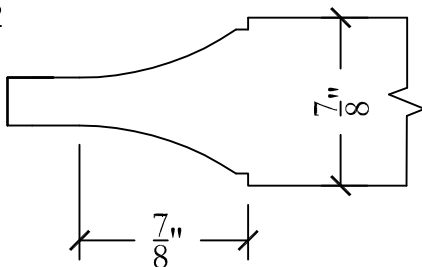

PR16

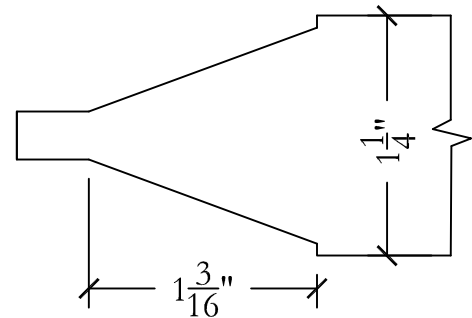

Note: Panel thickness will increase with tongue thickness.

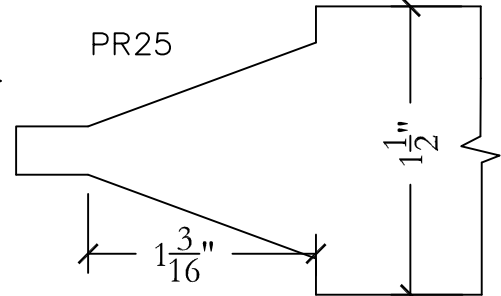
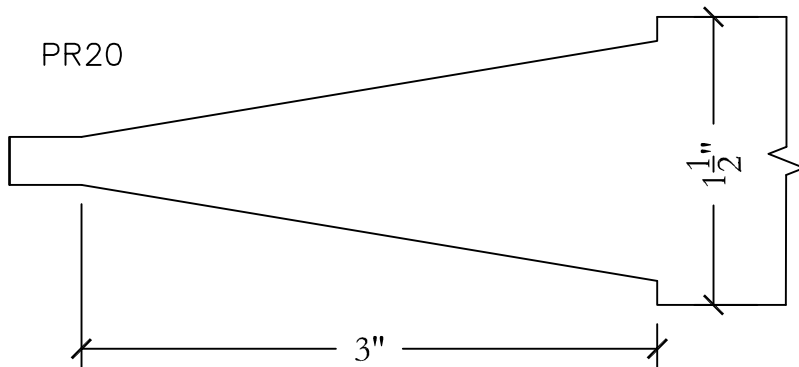
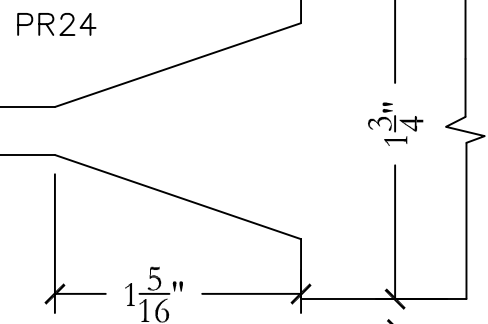
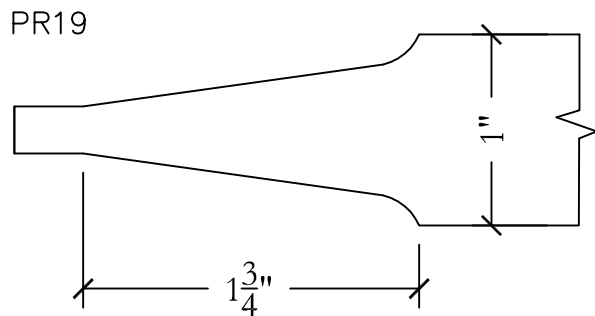
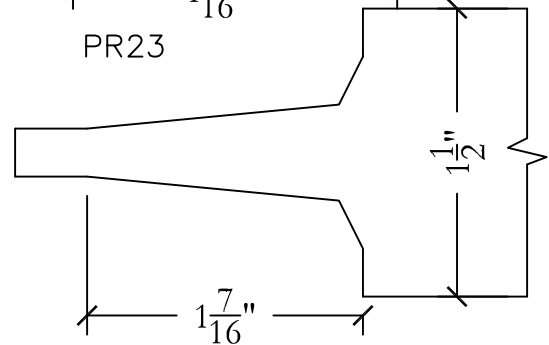
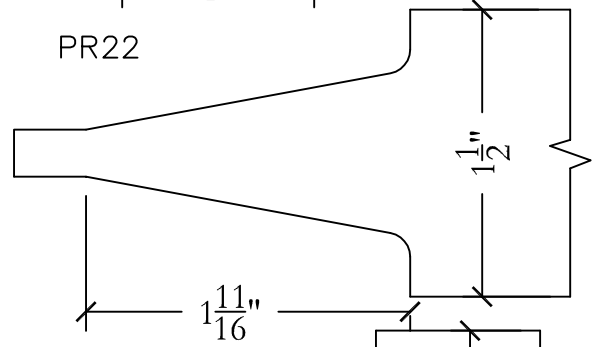
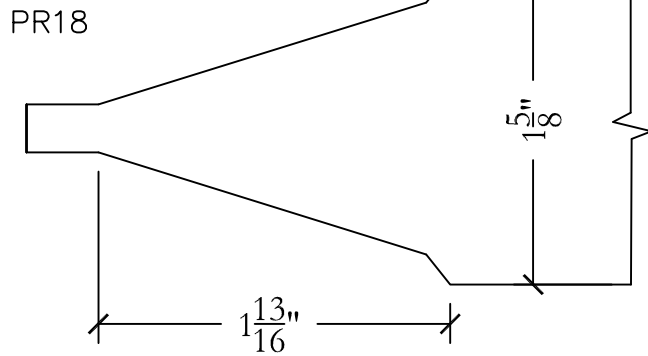
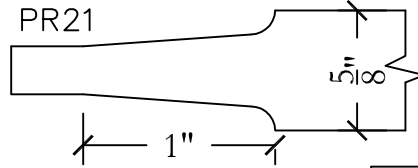
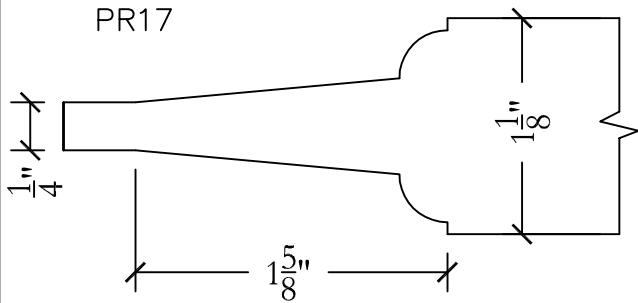

Note: Panel thickness will increase with tongue thickness.

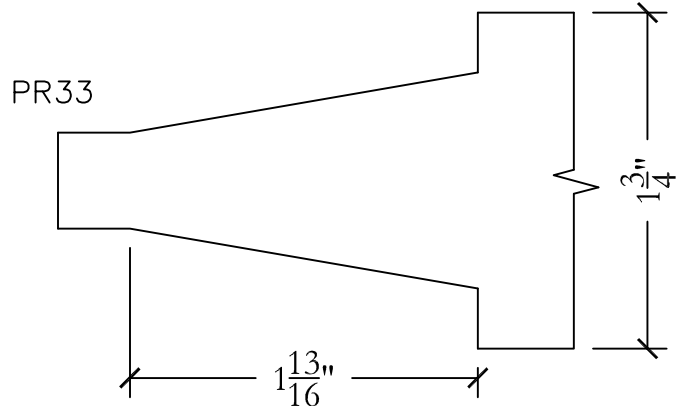
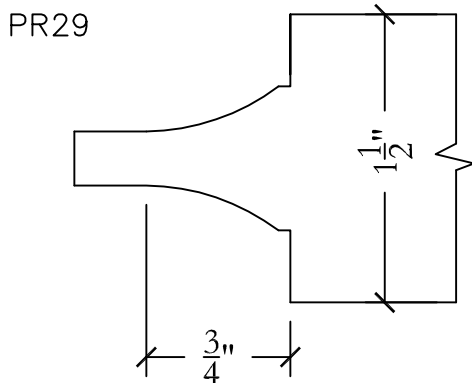
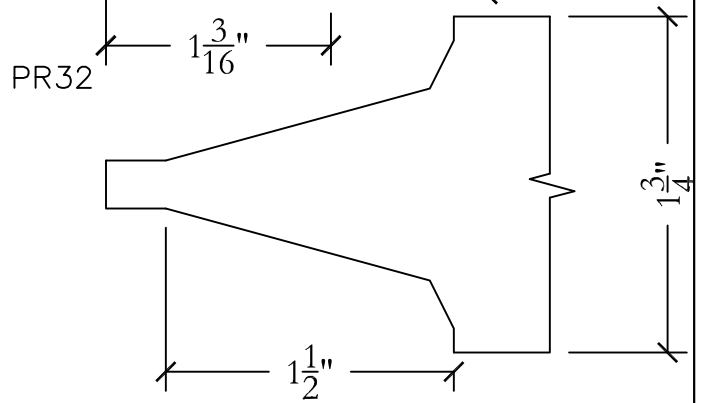
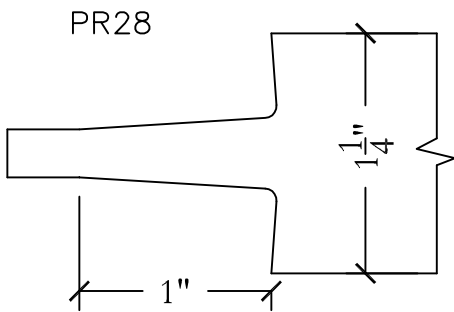
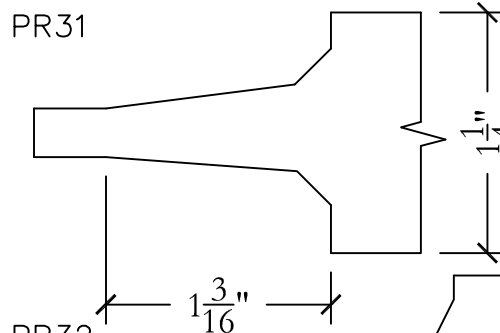
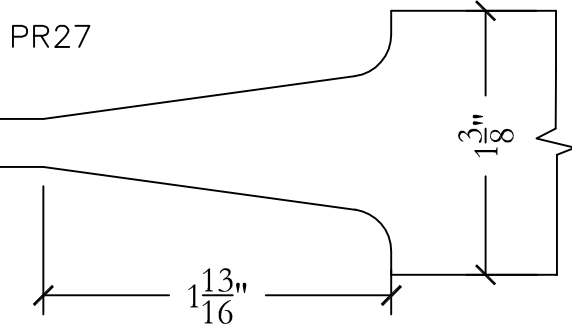
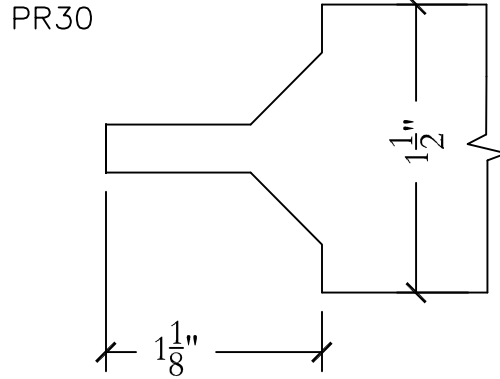
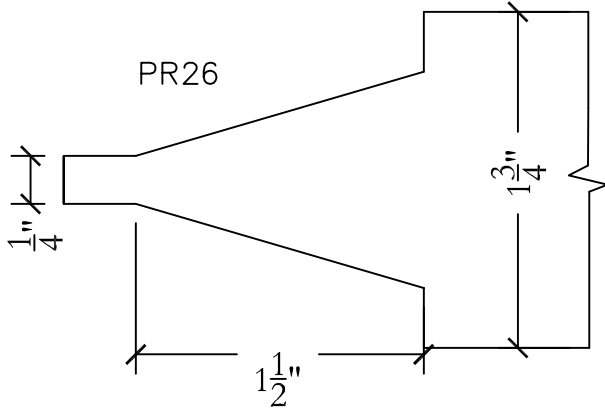

Note: Panel thickness will increase with tongue thickness.